

Installation Manual

Part List

Cabinet Inner Height (Unit:mm)

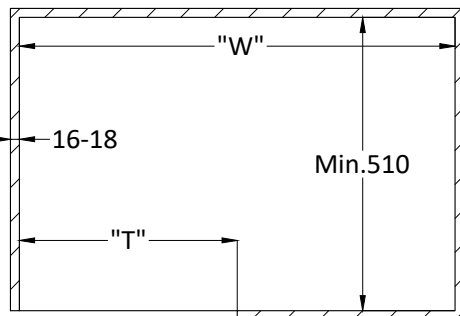
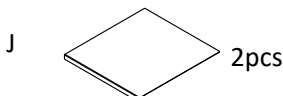
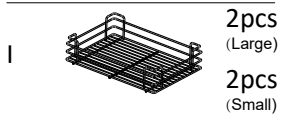
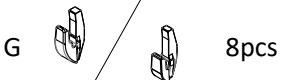
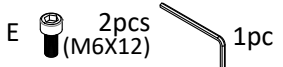
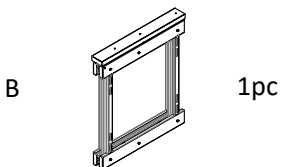

Cabinet Height	≥610	
Product Variation	For 32" Cabinet	For 36" Cabinet
T	≥345	≥380
W	≥620	≥660

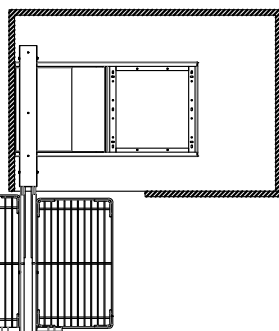
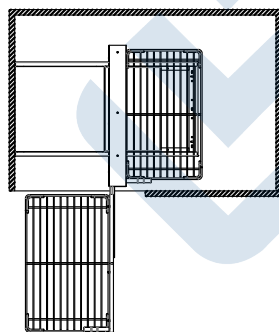

 The larger baskets should be hang on the open side.

Installation Steps

① Assemble the sliding frame.

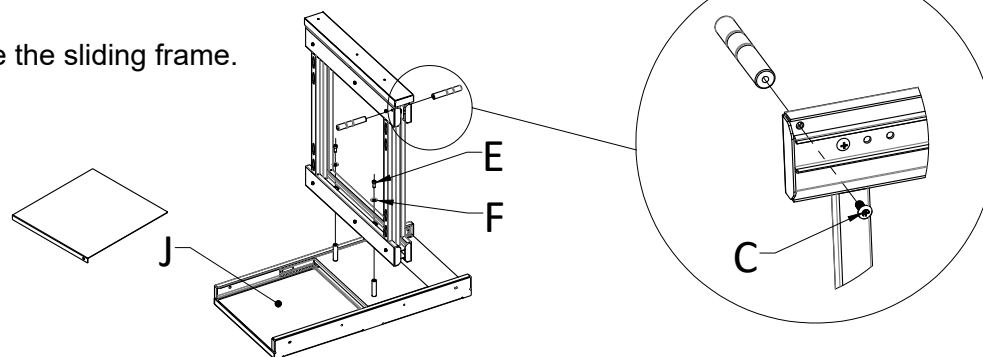

② Install the bottom holder to the cabinet.

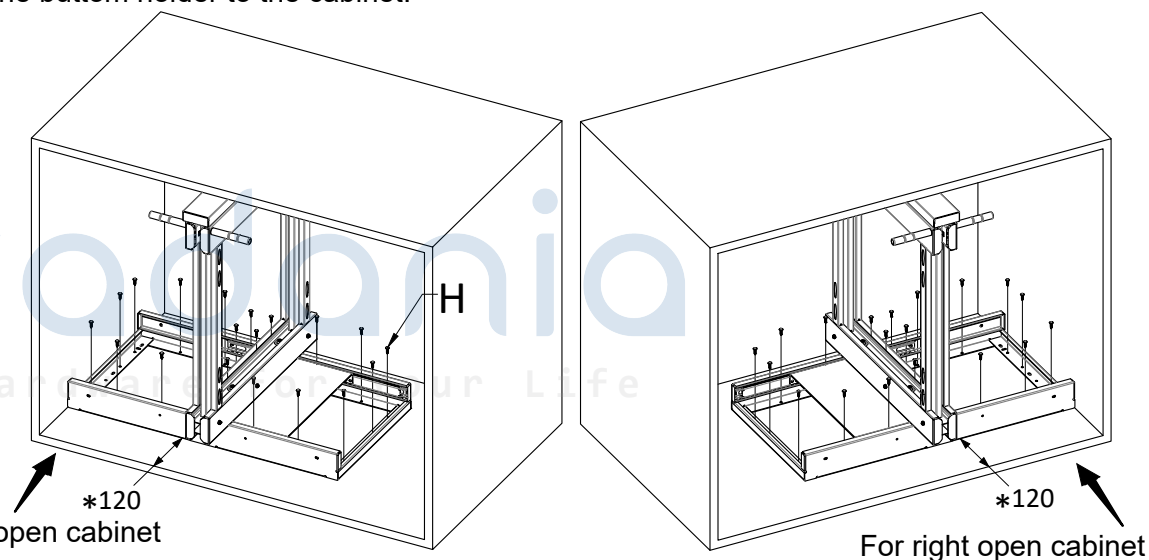

③ Hang the baskets on.

*The distance of bottom holder to the cabinet edge

